

WAVE MAKER



- ▶ Wave direction adjustable.
- ▶ Powerful magnet base to fix the wave maker to the tank.
- ▶ Unique propeller design to create natural wave to aquariums.



HWM2000



HWM4000

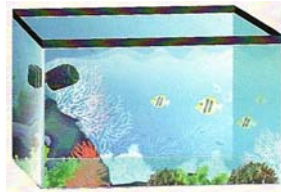

| MODEL | POWER | FLOW RATE | TANK SIZE |
|---------|-------|-----------|-----------|
| HWM2000 | 3W | 600L/H | LESS 60L |
| HWM4000 | 6W | 1000L/H | 60-100L |

HIPPO POND UV STERILIZER FILTER

NEW



EPF-13500U

- Innovative backwash system for sucked-in waste auto-removal, easy to operate
- Patented design of viewable pressure-alarm indicator for timely reminding of backwash cleaning and maintenance
- Multi-layers of mechanical and biological filtration system containing 60 bio-balls and three layers of bio and filter sponge for removing harmful debris and breeding beneficial bacteria
- Optional version with integrated UV clarifier with superior shatterproof quartz sleeve brings even better filtration performance





| MODEL | DESCRIPTION | POWER | RECOMMENDED PUMP QMAX |
|------------|--|-------|-----------------------|
| EPF-13500U | Hippo pond UV sterilizer filter UV lamp 18W | 24W | 18000L/Hr |

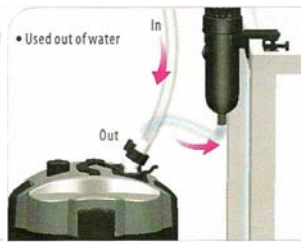
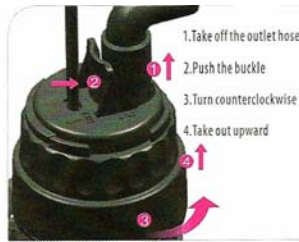

MINI UV CLARIFIER

NEW



-  Patented safety protection system.
-  Fully sealed lamp holder.
-  Can be used both in and out of water.
-  Efficiently kills algae in small tanks

| MODEL | POWER | WATER PUMP |
|--------|-------|--------------|
| UV1205 | 5W | LESS 1500L/H |

UV STERILISER UNIT

UV STERILISER UNIT

UV CLARIFIE



| Model | Power | Water Pump |
|--------|-------|---------------|
| UV1209 | 9W | 1500-4000L/H |
| UV1218 | 18W | 4000-10000L/H |
| UV1236 | 36W | 9000-15000L/H |

PT GLASS PET TERRARIUM



PT-400



PT-600

- Suitable for small pets, such as turtles, snakes, cabrites, frogs, and hermit crabs
- Convenient for maintenance with the moveable front door and top cover
- The door is designed with a lock for safety
- Open cover design for good ventilation

| MODEL | DIMENSION (mm) |
|--------|----------------|
| PT-400 | 438x278x340 |
| PT-600 | 620x370x470 |

PA PLASTIC PET TANK



- Suitable for small pets, such as turtles, snakes, cabrites, frogs, and hermit crabs
- Stylish top cover design with easy-to-reach feeding window
- Stores-flat handle for convenient carrying
- Good choice for a child's first pet tank

| MODEL | TANK SIZE | DIMENSION (mm) |
|---------|-----------|----------------|
| PA-230 | 2.4L | 230X130X180 |
| PA-230A | 2.4L | 230X130X180 |
| PA-270 | 4.0L | 270X160X190 |
| PA-330 | 6.5L | 330X190X240 |
| PA-380 | 11L | 380X230X260 |
| PA-460 | 18L | 460X270X300 |



HEAT TREE STUMP



- Natural design and easy to operate
- Safe and energy-saving with inbuilt temperature controller
- Giving the reptile a comfortable environment and making reptile-keeping easy

| MODEL | DESCRIPTION | DIMENSION (mm) |
|----------|------------------------------------|----------------|
| HTS-0505 | Heating tree stump 5W, 26 Deg. C. | 135x115x120mm |
| HTS-0515 | Heating tree stump 15W, 26 Deg. C. | 145x140x160mm |
| HTS-0520 | Heating tree stump 15W, 26 Deg. C. | 400x400x300mm |

HEATING CABLE



- Silicon cable
- Extra thin design maximum flexibility
- Even heating supply to the entire substrate surface
- With suction cups for easy securing

| MODEL | DESCRIPTION | RECOMMENDED TERRARIUM |
|---------|----------------------------------|-----------------------|
| HTC-300 | Reptile heating cable 15W, 3m. | 20-50L |
| HTC-450 | Reptile heating cable 25W, 4.5m. | 40-70L |
| HTC-600 | Reptile heating cable 50W, 6m. | 60-150L |
| HTC-750 | Reptile heating cable 90W, 7.5m. | 120-150L |

HEAT ROCK



- Built in thermostat ensures the constant temperature.
- Electronically controlled heating element.
- Even heat distribution.
- Will not overheat.
- Non toxic material

| MODEL | DESCRIPTION | RECOMMENDED TERRARIUM |
|---------|--------------------------------------|-----------------------|
| HR-0205 | Reptile heating rock 3W, 26 Deg. C. | 165x115x50mm |
| HR-0410 | Reptile heating rock 5W, 26 Deg. C. | 165x130x50mm |
| HR-0615 | Reptile heating rock 8W, 26 Deg. C. | 195x180x60mm |
| HR-0815 | Reptile heating rock 15W, 26 Deg. C. | 295x175x50mm |

REPTILE CAVE



RC-06



RC-02 / RC-04

| MODEL | SIZE |
|-------|---------------|
| RC-02 | 13.2 x8x4 |
| RC-04 | 14x9. 4x5 |
| RC-06 | 16. 3x10. 6x6 |

REPTILE BOWL



RWB-02



RWB-04

| MODEL | DESCRIPTION | SIZE |
|--------|--------------------------|---------------|
| RWB-02 | Reptile Water Bowl Small | 20x13. 4x3. 4 |
| RWB-04 | Reptile Water Bowl Large | 22x17x4. 6 |



SPIRULINA FLOATING PELLETS



Ingredients: Fish meal, products and by products of: oil seeds and cereals, spirulina, premix, fish oil, pigments, attractants, colourants, immune stimulator and Astaxanthin 45mg/kg

Vitamin C Source: Ascorbic Acid Polyphosphate

Spirafloat floating is an excellent community food for growth, color and loaded with spirulina for all kinds of fishes.

| MODEL | DESCRIPTION | QTY |
|------------|--|-------|
| SPIF100100 | Spirafloat floating pellets 10mm in plastic bag, 1kg | 1 kg |
| SPIF10TUB1 | Spirafloat floating pellets 10mm in plastic tub 1L | 1 L |
| SPIF101500 | Spirafloat floating pellets 10mm, 15kg | 15 kg |
| SPIF060100 | Spirafloat floating pellets 6mm, 1kg | 1 kg |
| SPIF06TUB1 | Spirafloat floating pellets 6 mm in plastic tub 1L | 1 L |
| SPIF061500 | Spirafloat floating pellets 6mm, 15kg | 15 kg |
| SPIF030100 | Spirafloat floating pellets 3mm, 1kg | 1 kg |
| SPIF03TUB1 | Spirafloat floating pellets 3 mm in plastic tub 1L | 1 L |
| SPIF031500 | Spirafloat floating pellets 3mm, 15kg | 15 kg |
| SPIF020100 | Spirafloat floating pellets 2mm, 1kg | 1 kg |
| SPIF02TUB1 | Spirafloat floating pellets 2 mm in plastic tub 1L | 1 L |
| SPIF021500 | Spirafloat floating pellets 2mm, 15kg | 15 kg |

DELUX ORANGE FLOATING PELLETS

Ingredients: Fish meal, products and by products of: oil seeds and cereals, pigments, premix, fish oil, attractants, colourants, immune stimulator and Astaxanthin 25mg/kg

Vitamin C Source: Ascorbic Acid Polyphosphate

Orafloat Floating is an excellent community floating food. It contains high protein and excellent for color.



| MODEL | DESCRIPTION | QTY |
|------------|---|-------|
| ORAF060100 | Orafloat floating pellets 6mm, 1kg | 1 kg |
| ORAF06TUB1 | Orafloat floating pellets 6mm in plastic tub 1L | 1 L |
| ORAF061500 | Orafloat floating pellets 6mm, 15kg | 15 kg |
| ORAF030100 | Orafloat floating pellets 3mm, 1kg | 1 kg |
| ORAF03TUB1 | Orafloat floating pellets 3mm in plastic tub 1L | 1 L |
| ORAF031500 | Orafloat floating pellets 3mm, 15kg | 15 kg |
| ORAF020100 | Orafloat floating pellets 2mm, 1kg | 1 kg |
| ORAF02TUB1 | Orafloat floating pellets 2mm in plastic tub 1L | 1 L |
| ORAF021500 | Orafloat floating pellets 2mm, 15kg | 15 kg |

HIGH QUALITY FISH FOOD

HIGH PROTEIN SINKING GRANULES



Ingredients: Fish meal, wheatmeal, fish oil, sojameal, premix, attractants, E127 and E172

Vitamin C Source: Ascorbic Acid Polyphosphate

Probits Sinking pellet is an excellent sinking bit for the community tank. It contains high protein for growing fish and for color.

| MODEL | DESCRIPTION | QTY |
|------------|---|-------|
| PROS010100 | Probits sinking granules 1mm, 1kg | 1 kg |
| PROS01TUB1 | Probits sinking granules 1mm in plastic tub, 1L | 1 L |
| PROS01TUB2 | Probits sinking granules 1mm in plastic tub, 1.8L | 1.8L |
| PROS012000 | Probits sinking pellets 1mm, 20kg | 20 kg |
| PROS020100 | Probits sinking pellets 2mm, 1kg | 1 kg |
| PROS02TUB1 | Probits sinking granules 1mm in plastic tub, 1L | 1 L |
| PROS02TUB2 | Probits sinking granules 1mm in plastic tub, 1.8L | 1.8L |
| PROS022000 | Probits sinking pellets 2mm, 20kg | 20 kg |
| PROS030100 | Probits sinking pellets 3mm, 1kg | 1 kg |
| PROS03TUB1 | Probits sinking granules 1mm in plastic tub, 1L | 1 L |
| PROS03TUB2 | Probits sinking granules 1mm in plastic tub, 1.8L | 1.8L |
| PROS032000 | Probits sinking pellets 3mm, 20kg | 20 kg |

PREMIUM SINKING PELLETS

Ingredients: Fish meal, products and by products of cereals, fishoil, premix, attractants

Vitamin C Source: Ascorbic Acid , Polyphosphate,

Premium Start is an ideal sinking pellet food for all your small fishes such as tetra, clown loach, small/baby cichlids and algae eaters. It contains high protein for growing fishes.



| MODEL | DESCRIPTION | QTY |
|------------|--|-------|
| PRES010100 | Premium Start sinking pellets 1mm, 1kg | 1 kg |
| PRES01TUB1 | Premium Start sinking pellets 1mm in plastic tub, 1L | 1 L |
| PRES01TUB2 | Premium Start sinking pellets 1mm in plastic tub, 1.8L | 1.8L |
| PRES012000 | Premium Start sinking pellets 1mm, 20kg | 20 kg |
| PRES020100 | Premium Start sinking pellets 2mm, 1kg | 1 kg |
| PRES02TUB1 | Premium Start sinking pellets 1mm in plastic tub, 1L | 1 L |
| PRES02TUB2 | Premium Start sinking pellets 1mm in plastic tub, 1.8L | 1.8L |
| PRES022000 | Premium Start sinking pellets 2mm, 20kg | 20 kg |



SUPREME SINKING PELLETS

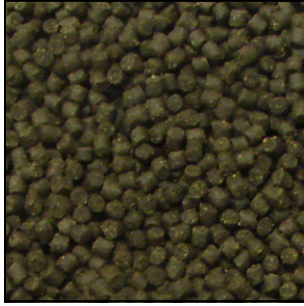

Ingredients: Fish meal, Soya meal, fish oil, wheat, vitamin and mineral premix

Vitamin C Source: Ascorbic Acid Polyphosphate

Supreme sinkers is a high protein food for the fish which love to feed from the bottom such as all the loaches, American cichlids and African cichlids. Ideal food the aquarium with the over flow filters.

| MODEL | DESCRIPTION | QTY |
|-------------|---|-------|
| SUPS030100 | Supreme Sinkers 3mm, 1kg | 1 kg |
| SUPS03TUB1 | Supreme Sinkers 3mm in plastic jar 1L | 1 L |
| SUPS032500 | Supreme Sinkers 3mm, 25kg | 25 kg |
| SUPS0450100 | Supreme Sinkers 4.5mm, 1kg | 1 kg |
| SUPS045TUB1 | Supreme Sinkers 4.5mm in plastic jar 1L | 1 L |
| SUPS0452500 | Supreme Sinkers 4.5mm, 25kg | 25 kg |
| SUPS060100 | Supreme Sinkers 6mm, 1kg | 1 kg |
| SUPS06TUB1 | Supreme Sinkers 6mm in plastic jar 1L | 1 L |
| SUPS062500 | Supreme Sinkers 6mm, 25kg | 25 kg |

HIGH QUALITY FISH FOOD

SUPER RED

| MODEL | QTY |
|-----------|------|
| supred050 | 50g |
| supred150 | 150g |
| supred300 | 300g |
| supred900 | 900g |

A red color enhancer food with PSB and Astaxanthin to enhance red color on all kinds of fish which has red color base. PSB itself act as color enhancer, however, the outstanding deep red from Super Red is more accepted by all fish hobbyist. Fish color improvement will be noticed within 7 days. This food does not contain sex hormone and is suitable for goldfish, koi, arrowana, oscar, red gourami, and all kinds of red color fish.



SUPER GREEN

| MODEL | DESCRIPTION | QTY |
|-----------|---------------------|------|
| supgre050 | SUPER Green | 50g |
| supgre150 | SUPER Green | 150g |
| supgre300 | SUPER Green | 300g |
| supgre900 | SUPER Green | 900g |
| supgrs050 | Super Green Sinking | 50g |
| supgrs150 | Super Green Sinking | 150g |
| supgrs300 | Super Green Sinking | 300g |
| supgrs900 | Super Green Sinking | 900g |

A very special food added with high concentration of PSB and spirulina, formulated to enhance very color on all kinds of fish, such as blue, green, black, platinum, yellow and etc. PSB and spirulina will give all kinds of fish their natural color. This special food will enhance full fish color within short time. Fish color improvement will be noticed within 7 days. It is suitable for goldfish, koi, cichlids, and all kind of fish



ADP SUPER RED

| MODEL | QTY |
|------------|-------|
| adpred050 | 50g |
| adpred150 | 150g |
| adpred500 | 500g |
| adpred1000 | 1000g |

A red color enhancer food with PSB and Astaxanthin to enhance red color on all kinds of fish which has red color base. PSB itself act as color enhancer, however, the outstanding deep red from Super Red is more accepted by all fish hobbyist. Fish color improvement will be noticed within 7 days. This food does not contain sex hormone and is suitable for small size fishes such as tetras, gourami, guppy, and all kinds of red color fish.



ADP SUPER GREEN

| MODEL | QTY |
|------------|-------|
| adpgre050 | 50g |
| adpgre150 | 150g |
| adpgre500 | 500g |
| adpgre1000 | 1000g |

A very special high protein granular food added with high concentration of PSB and spirulina, formulated to enhance every color on all kinds of fish, such as blue, green, black, platinum, yellow and etc. PSB and spirulina will give all kinds of their natural color. This special food will enhance full fish color within short time. Fish color improvement will be noticed within 7 days. This food is most suitable for small size fish such as neons, cardinals, tetras, rasboras, guppies, fighting fish, cichlids and all kind of small fish.

WHITE CRANE FISH FOOD



DISCUS BITS

| MODEL | QTY |
|------------|------|
| disbit030 | 30g |
| disbit150 | 150g |
| disbit400 | 400g |
| disbit1000 | 1kg |

A basic complete food for Discus with PSB added, for enhancing health and color of discus. This food can be used on all kinds of fish, not only discus fish.

DISCUS RED

| MODEL | QTY |
|------------|------|
| disred030 | 30g |
| disred150 | 150g |
| disred400 | 400g |
| disred1000 | 1kg |

A red color enhancer fish food to enhance all color on Discus/tropical fish, especially red color. This food can be used on all kinds of fish, not only discus fish. This product does not contain sex hormone and full color can be expected within 15 days.



DISCUS GOLD

| MODEL | QTY |
|------------|------|
| disgol030 | 30g |
| disgol150 | 150g |
| disgol400 | 400g |
| disgol1000 | 1kg |

A yellow gold color enhancer discus food to enhance yellow base Discus to give deeper gold color, it also enhances red color to become more bright. This product does not contain sex hormone and fish color could be expected within 15 days. This food can be used for all kinds



COFFS HARBOUR

| Weight | Item code |
|--------|-----------|
| 2kg | COF020 |
| 5kg | COF050 |
| 10kg | COF100 |
| 15kg | COF150 |



GOLDEN HARBOUR

| Weight | Item code |
|--------|-----------|
| 2kg | GS020 |
| 5kg | GS050 |
| 10kg | GS100 |
| 15kg | GS150 |

FINE DIAMOND

| Weight | Item code |
|--------|-----------|
| 2kg | FD020 |
| 5kg | FD050 |
| 10kg | FD100 |
| 15kg | FD150 |



SNOW WHITE (0-1mm)

| Weight | Item code |
|--------|-----------|
| 2kg | SW0020 |
| 5kg | SW0050 |
| 10kg | SW0100 |
| 15kg | SW0150 |

OCEAN GREEN

| Weight | Item code |
|--------|-----------|
| 2kg | OG020 |
| 5kg | OG050 |
| 10kg | OG100 |
| 15kg | OG150 |





NATURAL BLACK (3-6 mm)

| Weight | Item code |
|--------|-----------|
| 2kg | NBG3020 |
| 5kg | NBG3050 |
| 10kg | NBG3100 |
| 15kg | NBG3150 |

WHITE CHIP MARBLE (5-6mm)

| Weight | Item code |
|--------|-----------|
| 2kg | WCM5020 |
| 5kg | WCM5050 |
| 10kg | WCM5100 |
| 15kg | WCM5150 |



WHITE CHIP MARBLE (2-3mm)

| Weight | Item code |
|--------|-----------|
| 2kg | WCM5020 |
| 5kg | WCM5050 |
| 10kg | WCM5100 |
| 15kg | WCM5150 |

MACHINE WHITE (5-6mm)

| Weight | Item code |
|--------|-----------|
| 2kg | MW5020 |
| 5kg | MW5050 |
| 10kg | MW5100 |
| 15kg | MW5150 |



OX BLOOD MARBLE CHIP (2-3mm)

| Weight | Item code |
|--------|-----------|
| 2kg | OBC2020 |
| 5kg | OBC2050 |
| 10kg | OBC2100 |
| 15kg | OBC2150 |

CORAL SAND (0-1mm)

| Weight | Item code |
|--------|-----------|
| 2kg | CCS0020 |
| 5kg | CCS0050 |
| 10kg | CCS0100 |
| 15kg | CCS0150 |



CORAL SAND (1-2mm)

| Weight | Item code |
|--------|-----------|
| 2kg | CCS1020 |
| 5kg | CCS1050 |
| 10kg | CCS1100 |
| 15kg | CCS1150 |

CRUSH CORAL (1-4cm)

| Weight | Item code |
|--------|-----------|
| 2kg | CCS3020 |
| 5kg | CCS3050 |
| 10kg | CCS3100 |
| 15kg | CCS3150 |



CRUSH CORAL (3-5cm)

| Weight | Item code |
|--------|-----------|
| 2kg | CCS5020 |
| 5kg | CCS5050 |
| 10kg | CCS5100 |
| 15kg | CCS5150 |

CRUSH CORAL (4-7cm)

| Weight | Item code |
|--------|-----------|
| 2kg | CCS9020 |
| 5kg | CCS9050 |
| 10kg | CCS9100 |
| 15kg | CCS9150 |





NATURAL COLORED (2-3mm)

| Weight | Item code |
|--------|-----------|
| 2kg | NCG2020 |
| 5kg | NCG2050 |
| 10kg | NCG2100 |
| 15kg | NCG2150 |

NATURAL COLORED (5-6 mm)

| Weight | Item code |
|--------|-----------|
| 2kg | NCG5020 |
| 5kg | NCG5050 |
| 10kg | NCG5100 |
| 15kg | NCG5150 |





COLORED GRAVEL BLUE

| Weight | Item code |
|--------|-----------|
| 1kg | CG1BL |
| 2kg | CG2BL |



COLORED GRAVEL YELLOW

| Weight | Item code |
|--------|-----------|
| 1kg | CG1YE |
| 2kg | CG2MYE |

COLORED GRAVEL PURPLE

| Weight | Item code |
|--------|-----------|
| 1kg | CG1PU |
| 2kg | CG2MPU |



COLORED GRAVEL MIXED

| Weight | Item code |
|--------|-----------|
| 1kg | CG1MI |
| 2kg | CG2MI |

COLOURED GRAVEL

COLORED GRAVEL



COLORED GRAVEL GREEN

| Weight | Item code |
|--------|-----------|
| 1kg | CG1GR |
| 2kg | CG2GR |

COLORED GRAVEL PINK

| Weight | Item code |
|--------|-----------|
| 1kg | CG1PI |
| 2kg | CG2PI |



COLORED GRAVEL RED

| Weight | Item code |
|--------|-----------|
| 1kg | CG1RE |
| 2kg | CG2RE |



HF1003
15 x 12 x 12



HF1008
23.5 x 10 x 19.5



HF1010
11.5 x 8.5 x 8.5



HF1011
10.5 x 7.5 x 11



PF3131
42 x 15.5 x 24



HF1024
22.5 x 10.5 x 13.5



HF1025
13.5 x 6.5 x 10



HF1027
25.5 x 15.5 x 11



HF1028
21 x 11 x 10.5



HF1039



HF1041
31.5 x 5.5 x 13.5



HY01362
26 x 10 x 14



HY01371
22 x 16 x 13



HY0451
14 x 14 x 28



HY01361
26 x 10 x 14



PF3149
43 x 17 x 21.5



PF2014A
10 x 8 x 14



PF2014B
10 x 8 x 14



PF2014C
10 x 8 x 14



PF2020
11 x 8 x 10



PF9912
11 x 8 x 13



PF2031
24 x 7.5 x 8



PF2033
21 x 7.5 x 8

ORNAMENTS



PF3015

17 x 9 x 15



PF3016

17 x 10.5 x 15



PF3017

15 x 10 x 15



PF3019

18 x 8 x 15



PF3025

12 x 9 x 13



PF9927

25 x 15.5 x 18



PF9929

25 x 15.5 x 18



PF3080

23 x 16 x 12



PF98220A
16 x 11 x 11.5



PF98220B
14 x 9.5 x 10.5



PF98220C
11 x 7.5 x 8



PF3104A
88 x 28.5 x 39



PF3104B
62 x 20 x 30



PF3104C
42.5 x 15 x 21



PF3121
25 x 13.5 x 11



PF3089
14.6 x 16.5 x 5

ORNAMENTS



R8017
8 x 8 x 17



R8018
7.5 x 8 x 16



R8020
17 x 10 x 19



R8022
12 x 7 x 17



R8031
13 x 9 x 11



R8039
21 x 13.5 x 12.5



R8040
18.3 x 18.5



R8041
21.2 x 17.5 x 5



PF3128

Set of 12

ORNAMENTS



ORNAMENTS



QS5050



QS5043



QS5045



QS5046



QS5049



R8043
20.5 X 12.5 X 13.5



R8497C
12.5 X 11.3 X 7.8



R8516A
39.5 X 17 X 16.5



R8605
12 x 10 x 19



R8612
16 x 12 x 23



R8629
24 x 18 x 24



R8631
12.5 x 12 x 20



R8652
13 x 9 x 12



R8717
18 x 10 x 22



R8856A
12.5 x 10.5 x 21.5



R8856B
13 x 10 x 23



R8913
13 x 11 x 14



R9004
14 x 6 x 14



R84111
14 x 7.5 x 14.5



R84113
15.5 x 8 x 15



RST01P



R88706
20 x 6.5 x 12



R88708
25 x 3.5 x 17



R88709
25 x 8 x 15



R88901
13 x 17 x 11



R88903
16 x 6 x 12



R88904
11 x 7 x 14



R88905
15 x 10 x 17



R882206
29 x 10 x 10.5



R883010
25 x 6.5 x 15



R887010
15 x 3.5 x 17



R888105
25 x 10 x 11

FISH TANKS WITH WEIRS



Fish tanks with weirs, meaning; they come with an overflow box in the corner of the fish tank with A 45mm Hole and plastic mesh.



| MODEL | Dimension (in mm): L x W x H | Glass Thickness |
|------------|---|-----------------|
| R322W | 3'x2'x2'(Weir) : 920 x 610 x 610 mm | 10mm |
| R422W | 4'x2'x2' (Weir) : 1220 X 610 X 610 mm | 10mm |
| R522W | 5'x2'x2' (Weir) : 1530 x 610 x 610 mm | 10mm |
| R622W | 6'x2'x2' (Weir) : 1830 x 610 x 610 mm | 10mm |
| R622W 12mm | 6'x2'x2' (Weir) : 1830 x 610 x 610 mm | 12mm |
| R4225W | 4' x 2' x 2.5' (Weir) : 1220 x 610 x 760 mm | 12mm |
| R5225W | 5' x 2' x 2.5' (Weir) : 1530 x 610 x 760 mm | 12mm |
| R6225W | 6' x 2' x 2.5' (Weir) : 1830 x 610 x 760 | 12mm |
| BOX-455 | 6mm box for weir | 6mm |



FISH TANK WITH A BUILT IN CORNER

FISH TANK



FISH TANKS WITH A BUILT IN CORNER FILTRATION SYSTEM.

| Model | DESCRIPTION | THICKNESS |
|---------|--|-----------|
| R31420F | 3'x14"x20" corner filter : 920 x 360 x 500 mm | 6mm |
| R41420F | 4'x14"x20" corner filter : 1220 x 360 x 500 mm | 6mm |
| R422F | 4'x2'x2' corner filter : 1220 X 610 X 610 mm | 10mm |
| R522F | 5'x2'x2' corner filter : 1530 X 610 X 610 mm | 10mm |
| R622F | 6'x2'x2' corner filter : 1830 x 610 x 610 mm | 10mm |



FISH TANKS WITH A BUILT IN CORNER FILTRATION and SLIDING LID SYSTEM

| MODEL | DESCRIPTION | THICKNESS |
|----------|--|-----------|
| R21818FS | 2'x18"x18" corner filter, sliding lid : 610 X 460 X 460 | 6mm |
| R31420FS | 3'x14"x20" corner filter, sliding lid : 920 x 360 x 500 | 6mm |
| R41420FS | 4'x14"x20" corner filter, sliding lid : 1220 x 360 x 500 | 6mm |

BETTA GLASS FISH TANKS



BET1S



BET2S



BET3S



BET4S

| MODEL | DESCRIPTION |
|-------|--------------------------|
| BET1S | Single fighter tank |
| BET2S | Two Sectioned with lid |
| BET3S | Three sectioned with Lid |
| BET4S | Four Sectioned with lid |



| MODEL | DESCRIPTION |
|---------|---|
| BET3LR | Three stack three section fighter tank with filter |
| BET3LRC | Three stack three section fighter tank with filter Includes:SLK050, SP500, Carbon and cotton |



BETTA GLASS FISH TANK



BET1RE/BET1REC



BET2RE/BET2REC



BET3RE/BET3REC



BET4RE/BET4REC





| MODEL | DESCRIPTION |
|--------|--|
| BET1RE | Single fighter tank with internal mini reef |
| BET2RE | 2 section fighter tank with internal mini reef |
| BET3RE | 3 section fighter tank with internal mini reef |
| BET4RE | 4 section fighter tank with internal mini reef |

| MODEL | DESCRIPTION |
|---------|---|
| BET1REC | Single section COMPLETE fighter tank |
| | Includes: SLK025 Heater, SP500 water pump |
| | 150 Carbon, Cotton and hoses for the water pump. |
| BET2REC | 2 section fighter tank COMPLETE w/ int. mini reef |
| | Includes: SLK025 Heater, SP500 water pump |
| | 150 Carbon, Cotton and hoses for the water pump. |
| BET3REC | 3 section fighter tank COMPLETE w/ int. mini reef |
| | Includes: SLK025 Heater, SP500 water pump |
| | 150 Carbon, Cotton and hoses for the water pump. |
| BET4REC | 4 section fighter tank COMPLETE w/ int. mini reef |
| | Includes: SLK025 Heater, SP500 water pump |
| | 150 Carbon, Cotton and hoses for the water pump. |

FISH TANK

FUCHA



-  Cabinet (Stained or pine with stainless steel handles)
-  Modern design with more storage space.
-  Flat top hood
-  Stainless steel legs





CROWN

- Cabinet (Stained or pine) with wooden knobs
- Standard Crown hood
- Heritage design



AQUARIUM FURNITURE

MODEX



- Cabinet (Stained or pine) with Stainless handle
- Standard hood
- Modern design





COLONIAL



- Cabinet (stained or pine) with stainless steel knobs
- Modern design
- Flat top hood



AQUARIUM FURNITURE

HERO STYLE (STAINED FINISH)



-  Cabinet (Stained or Pine) with Wooden knobs
-  Standard Hood
-  Heritage design





ABSOLUTE

HERO STYLE (SANDED FINISH)

- ✦ Stand made from Pine wood with sanded finish
(Also available stained by request)
- ✦ Standard hood made from pine wood with
sanded finish
- ✦ Standard basic design

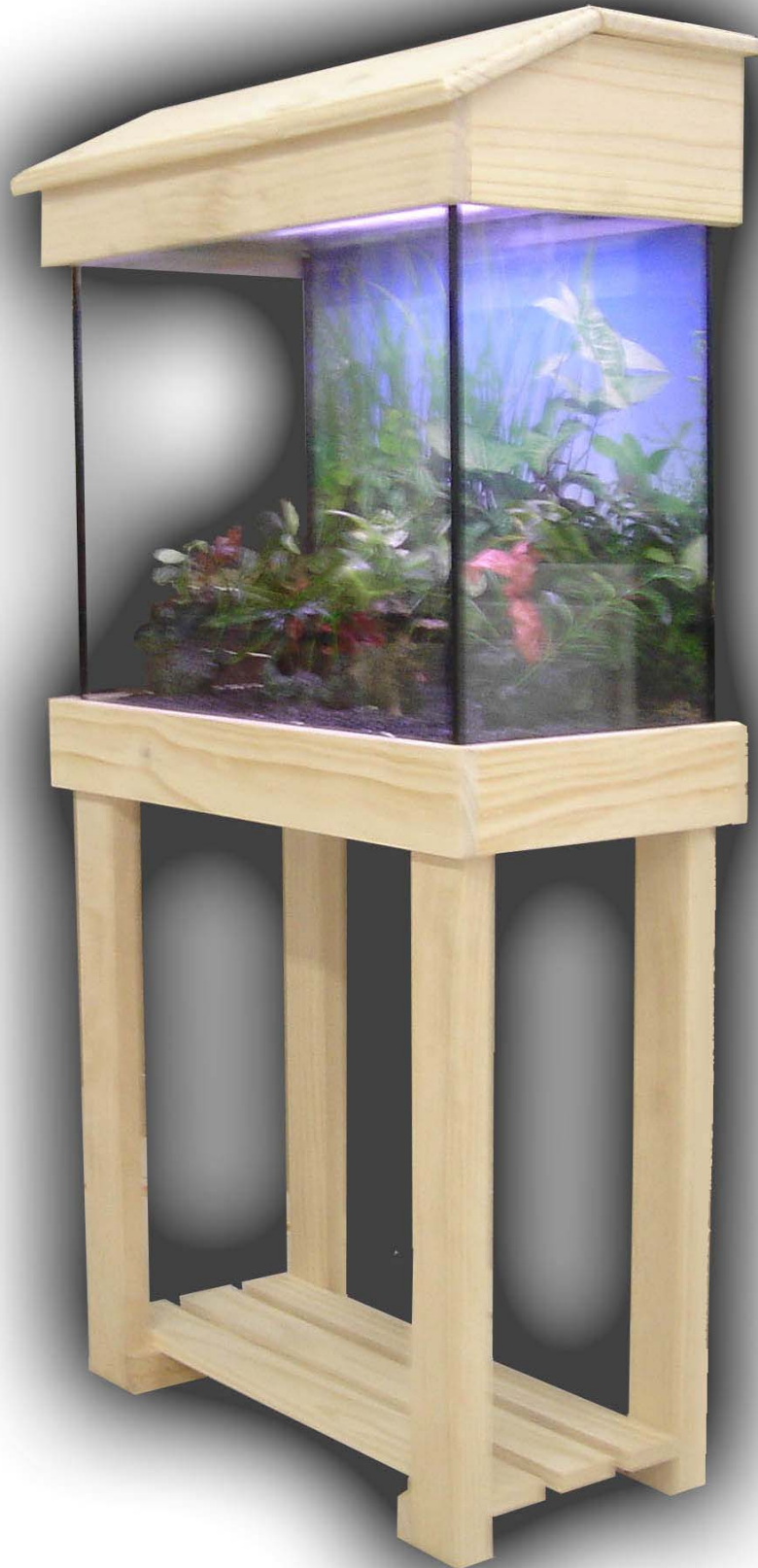

AQUARIUM FURNITURE

MODEX MK II



➤ Cabinet (Stained or pine) with stainless steel handle.

➤ Standard hood

➤ Stainless steel

➤ Modern design





Sedo 212

- ↳ Glossy Polyurethane Finish
- ↳ Filter, Light and Foam
- ↳ 10mm Thickglass (Black silicon)
- ↳ 3D Background



AQUARIUM FURNITURE

Sedo 212



- Glossy Polyurethane Finish
- Filter, Light and Foam
- 10mm Thickglass (Black silicon)
- 3D Background





SUARVE



- Glossy Polyurethane Finish
- Filter, Light and Foam
- 10mm Thickglass (Black silicon)
- 3D Background



AQUARIUM FURNITURE



RESUN Electromagnetic Air Pumps



- Convenient to operate and no lubricant needed.
- Strong and durable cylinder and piston result in high pressure and energy saving.
- Air dividers included with outlets varying from 4 to 22.
- Widely used in fish farms, seafood restaurants and aquariums for oxygenation purpose.

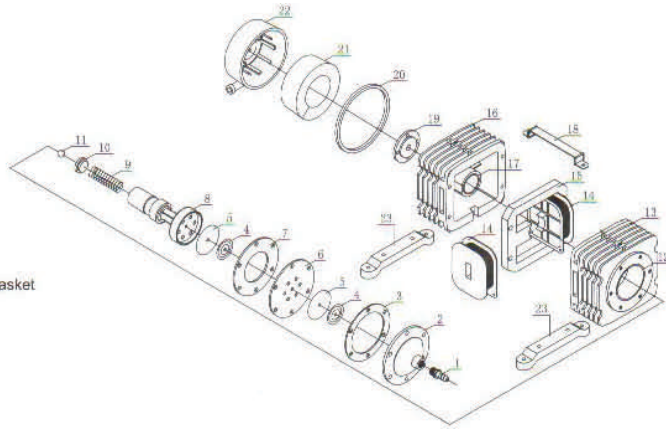
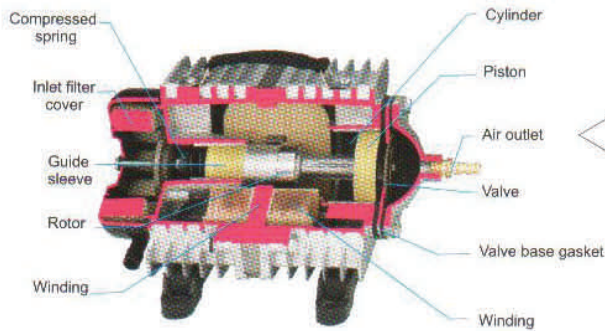

| | | | | | | | |
|---|--------------------|----|--------------------|----|-----------------|----|-----------------|
| 1 | Air Outlet | 7 | Valve base gasket | 13 | Front pump body | 19 | Steel ball base |
| 2 | Front cover | 8 | Piston Assembly | 14 | Winding | 20 | Filter gasket |
| 3 | Front cover gasket | 9 | Compressed spring | 15 | Iron core | 21 | Filter |
| 4 | Valve cover | 10 | Spring base | 16 | Back pump body | 22 | Filter cover |
| 5 | Valve | 11 | Steel ball | 17 | Guide sleeve | 23 | Foot plate |
| 6 | Valve base | 12 | Air chamber sleeve | 18 | Life belt | | |

| MODEL | DESCRIPTION | POWER | DIA. OF OUTLET | SPEC. OF DIVIDER | DIMENSION |
|---------|--------------------|-------|----------------|------------------|-------------------|
| ACO-001 | 0.02MPa, 30L/min | 18W | 8mm | 4 | 180 x 95 x 115mm |
| ACO-003 | 0.03Mpa, 60L/min | 35W | 10mm | 6 | 225 x 115 x 130mm |
| ACO-006 | 0.04Mpa, 90L/min | 80W | 10mm | 8 | 245 x 132 x 155mm |
| ACO-010 | 0.04Mpa, 170L/min | 200W | 12mm | 16 | 285 x 165 x 175mm |
| ACO-012 | 0.04Mpa, 200L/min | 280W | 16mm | 16 | 272 x 165 x 190mm |
| ACO-016 | 0.045Mpa, 230L/min | 380W | 16mm | 16 | 290 x 180 x 205mm |
| ACO-018 | 0.045Mpa, 250L/min | 380W | 16mm | 16 | 330 x 180 x 205mm |

AIR PUMPS

RESUN MPQ DC Air Pump



- High quality DC motor, quiet operating sound.
- Concussion-resistant diaphragm, advanced bearing and centrifugal shaft enhance a long product operating life.
- Provides oxygen to living fish in vehicles, stores and restaurants.

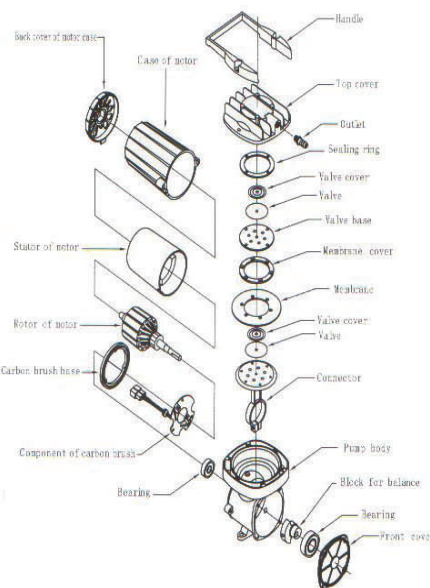
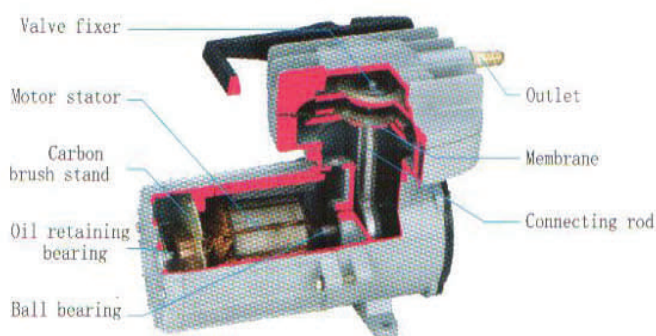

| MODEL | DESCRIPTION | POWER | DIA. OF OUTLET | SPEC. OF DIVIDER | DIMENSION |
|---------|--------------------|-------|----------------|------------------|-------------------|
| MPQ-906 | >0.13MPa, 130L/min | 120W | 10mm | 12 | 260 x 160 x 200mm |
| MPQ-905 | >0.12MPa, 105L/min | 100W | 10mm | 10 | 235 x 143 x 170mm |
| MPQ-904 | >0.12MPa, 90L/min | 60W | 10mm | 8 | 250 x 120 x 160mm |



RESUN GF Air Blower

- Heavy Duty Aluminum casing, durable and good heat diffusion.
- With very large air flow, especially good for aeration in fish farms and seafood restaurants.



| MODEL | OUTPUT | POWER | DIMENSION | REC. RETAIL PRICE |
|--------|------------|-------|-------------------|-------------------|
| GF120 | 11400L/Hr | 120W | 165 x 205 x 210mm | \$ |
| GF180 | 18000L/Hr | 180W | 200 x 230 x 225mm | \$ |
| GF370 | 37200L/Hr | 370W | 220 x 250 x 260mm | \$ |
| GF750 | 63000L/Hr | 750W | 230 x 295 x 260mm | \$ |
| GF1100 | 108000L/Hr | 1100W | 335 x 335 x 350mm | \$ |

AIR BLOWER

RESUN LP Low Noise Air Pump



- Impact resistant rubber diaphragm and valve ensure long life.
- Unique Structure with good heat dispersion and low noise.
- Widely used in fish farms, ponds, aquariums and industry uses for oxygenation purpose.
- Plastic air dividers included.



LP20



LP100

| MODEL | AIR FLOW | PRESSURE | POWER | AIR DIVIDER OUTLETS | AIR STONES MAX DEPTH | REC. RETAIL PRICE |
|-------|----------|----------|-------|------------------------|-------------------------|----------------------|
| LP20 | 1500L/Hr | 0.028Mpa | 17W | 6 | 2.2m | \$ |
| LP40 | 3000L/Hr | 0.030Mpa | 35W | 12 | 2.8m | \$ |
| LP60 | 4200L/Hr | 0.037Mpa | 50W | 14 | 3.5m | \$ |
| LP100 | 8400L/Hr | 0.042Mpa | 100W | 33 | 4.0m | \$ |



RESUN AC Whispa Air Pump

- Compact size, low noise and small vibration.
- Strong diaphragm and silicon valve for long life durability.



| MODEL | AIR FLOW | PRESSURE | AIR OUTLETS | POWER | AIR FLOW ADJUSTER | REC. RETAIL PRICE |
|--------|----------|-----------|-------------|-------|-------------------|-------------------|
| AC500 | 72L/Hr | >0.010Mpa | 1 | 2W | NO | \$ |
| AC1000 | 108L/Hr | >0.012Mpa | 1 | 2.5W | NO | \$ |
| AC1500 | 180L/Hr | >0.014Mpa | 2 | 3W | NO | \$ |
| AC2000 | 216L/Hr | >0.014Mpa | 2 | 3W | YES | \$ |

RESUN Surpass Air Pump

- Car shape design in silver gray colour.
- Safe design for both outdoor and indoor use.
- Suitable for aquarium and small water garden.



| MODEL | AIR FLOW | PRESSURE | AIR OUTLETS | POWER | AIR FLOW ADJUSTER | REC. RETAIL PRICE |
|---------|----------|-----------|-------------|-------|-------------------|-------------------|
| AIR1000 | 60L/Hr | >0.010Mpa | 1 | 2W | NO | \$ |
| AIR2000 | 140L/Hr | >0.016Mpa | 1 | 3W | NO | \$ |
| AIR3000 | 180L/Hr | >0.016Mpa | 2 | 3.5W | NO | \$ |
| AIR4000 | 320L/Hr | >0.016Mpa | 2 | 4W | YES | \$ |
| AIR8000 | 640L/Hr | >0.016Mpa | 4 | 8W | YES | \$ |

RESUN Battery Air Pump



Automatic change between AC and DC. Good backup during power outage

Integrated controller with effective noise damper.

Portable oxygen provider for transporting fish.



ACD-8800



ACD-6604



DC-120



DC-160

| MODEL | DESCRIPTION | POWER | Diamension (MM0 |
|----------|-------------------|-------|-----------------|
| ACD-8800 | 5L/min, 2 outlet | 10W | 180x170x78 |
| ACD-6604 | 10L/min, 4 outlet | 15W | 209x157x73 |
| DC-160 | Battery operated | | 143x75x50 |
| DC-120 | Battery operated | | 149x85x50 |



RESUN Ozone Processor

- Used to kill harmful bacteria and algae
- Increases oxygen supply while generating ozone
- Better when used with a protein skimmer or high polymer filter



RSO35



RSO280



RSO9805-0.25g

OZONE PROCESSOR

Ozone quantity sug-

gested in fresh water:

- Fish aquarium: 250mg ozone for 0.5 m3 water treatment per hour (Including volatilization)
- Water plant aquarium: 150mg ozone for 0.5 m3 water treatment per hour (Including volatilization)
- New aquarium: 150mg ozone for 0.5m3 water treatment per hour for the first time (Including volatilizing)

Ozone quantity suggested in marine water:



- Fish aquarium: 150mg ozone for 0.5 m3 water treatment per hour (Including volatilization)
- Reef and coral aquarium: 100mg ozone for 0.5 m3 water treatment per hour (Including volatilization)

| MODEL | Frequency | O3 Output | Diamension | Recommend Price |
|---------------|-----------|-----------|---------------|-----------------|
| RSO35 | 50/60 Hz | 0.35 GPH | 120x110x90 mm | |
| RSO9805-0.25g | 50/60 Hz | 0.25 GPH | 180x170x78 mm | |
| RSO280 | 50/60 Hz | 2.80 GPH | 320x245x180mm | |

RESUN Power Head



SP Series

-  Durable and stable. Enjoying good reputation in the market for years
-  Uses a stainless steel shaft and durable magnetic rotor
-  Low operating noise, energy efficient with little maintenance





| MODEL | DESCRIPTION | POWER | RECOMMEND PRICE |
|---------|----------------|-------|-----------------|
| SP-1100 | 500L/Hr, 0.7m | 8W | |
| SP-1200 | 700L/Hr, 0.8m | 12W | |
| SP-2500 | 1400L/Hr, 1.5m | 18W | |
| SP-3800 | 2000L/Hr | 25W | |

New

Power Head Bullet Submersible Series



-  Compact size and easy to install
-  Suitable for both fresh and marine water, and ideal for aquarium use

| MODEL | DESCRIPTION | POWER | RECOMMEND PRICE |
|--------|-------------|-------|-----------------|
| B-400 | 400L/Hr | 6W | |
| B-700 | 700L/Hr | 10W | |
| B-1000 | 1000L/Hr | 15W | |
| B-1500 | 1500L/Hr | 25W | |
| B-2000 | 2000L/Hr | 30W | |



RESUN Statuary Pump



SP-500



SP-600



SP-800/ SP-880



SP-980

- Compact size and with flow adjuster
- Completely sealed motor for maximizing the working durability
- Low noise in operating process
- For indoor and outdoor use
- Perfect choice for a table fountain and suitable for water circulation in a small aquarium or reptile tank

| MODEL | DESCRIPTION | POWER | Recommend Price |
|--------|----------------|-------|-----------------|
| SP-500 | 200L/Hr, 0.6m | 5W | |
| SP-600 | 260L/Hr, 0.45m | 5W | |
| SP-800 | 250L/Hr, 0.5m | 4W | |
| SP-880 | 370L/Hr, 0.75m | 5.2W | |
| SP-850 | 350L/Hr, 0.7m | 4W | |
| SP-980 | 500L/Hr, 1.3m | 7W | |

RESUN



SP Velocity Water Pump



- High lift and large flow output
- Epoxy-encapsulated and low powerconsumption motor
- Used both submersible and in-line

| MODEL | DESCRIPTION | POWER | RECOMMEND PRICE |
|----------|----------------|-------|-----------------|
| SP-6000 | 2800L/Hr, 2.5m | 40W | |
| SP-7500 | 3500L/Hr, 4.5m | 75W | |
| SP-9000 | 3500L/Hr, 3.5m | 130W | |
| SP-9000A | 3800L/Hr, 4.0m | 120W | |

SP Vertical Water Pump with/without Float Switch

- Energy efficient rare earth rotor creates powerful water flow
- Float switch protects the pump from running dry
- Inbuilt with thermostat and fully sealed motor for working reliably and safely
- Bottom inlet can pump water at a low level



| MODEL | DESCRIPTION | POWER | RECOMMEND PRICE |
|----------|-----------------|-------|-----------------|
| SP-9500 | 4000L/Hr, 4m | 100W | |
| SP-9600 | 8000L/Hr., 5.2m | 150W | |
| SP-9500S | 4000 L/Hr, 4m | 100W | |
| SP-9600S | 8000L/Hr, 5.2m | 230W | |



RESUN King Water Pump



King-1



King-1A



King-2



King-2A / King-3



King-3A/ King-4/ King-5/ King-6

- More powerful and energy-efficient rare earth rotor
- Wear-resistant ceramic shaft ensures long life
- Optional in-line use
- Encapsulated epoxy resin motor ensures safety, reliability and durability Suitable for both fresh and marine water
- Choices of fountain jets/kits
- Suitable for aquarium, water garden fountain and waterfall display

| MODEL | DESCRIPTION | POWER | Hmax. | RECOMMEND PRICE |
|---------|-------------|-------|--------------|-----------------|
| King-1 | 380 l/Hr | 7W | 0.90m, 3.0ft | |
| King-1A | 700L/Hr | 10W | 1.20m, 4.0ft | |
| King-2 | 1000L/Hr | 20W | 1.90m, 6.0ft | |
| King-2A | 1500L/Hr | 20W | 2.0m, 6.5ft | |
| King-3 | 2400L/Hr | 35W | 2.3m, 7.0ft | |
| King-3A | 4000L/Hr | 70W | 2.4m, 7.5ft | |
| King-4 | 5100L/Hr | 125W | 4.5m, 14.8ft | |
| King-5 | 6200L/Hr | 145W | 4.0m, 12.5ft | |
| King-6 | 8200L/Hr | 226W | 5.0m, 16.5ft | |

RESUN

Submersible Water Pump



NEW

- Stylish and unique patented design
- Compact size and easy to install
- Suitable for both fresh and marine water
- Provided with filter sponge
- Ideal for aquarium, pond, fountain and waterfall display
- A wide range of optional fountain heads



S-400 / S-700 / S-1000 / S-1500 / S-2000



S-3000 / S-4500 / S-7000 / S-10000

| MODEL | DESCRIPTION | POWER | DIMENSION (mm) | RECOMMEND PRICE |
|---------|-------------|-------|----------------|-----------------|
| S-400 | 400 L/Hr | 6W | 92.4X86X46 | |
| S-700 | 700 L/Hr | 10W | 93.4x92x49 | |
| S-1000 | 1000 L/Hr | 15W | 102.8x102x57 | |
| S-1500 | 1500 L/Hr | 25W | 123x63x124 | |
| S-2000 | 2000 L/Hr | 30W | 131x68.5x124.6 | |
| S-3000 | 3000 L/Hr | 60W | 136x120x74 | |
| S-4500 | 4500 L/Hr | 110W | 167.5x140x88 | |
| S-7000 | 7000 L/Hr | 140W | 170x120x150 | |
| S-10000 | 10000 L/Hr | 230W | 220x140x171 | |



RESUN

Sea Lion Water Pump



- Vortex impeller rotating in one direction for energy efficiency
- Anti-corrosive and wear-resistant ceramic shaft
- Unique design for multi-way installation and free positioning
- Inbuilt with thermostat and fully sealed motor for working reliably and safely
- In-line use available
- Strong water flow and pumping capacity. Ideal for large waterfalls and big filtration systems

| MODEL | DESCRIPTION | POWER | Hmax. | RECOMMEND PRICE |
|----------|-------------|-------|--------------|-----------------|
| PG-6000 | 6000 L/Hr | 150W | 5.0m, 16.4ft | |
| PG-8000 | 8000 L/Hr | 200W | 7.0m, 23.0ft | |
| PG-10000 | 10000 L/Hr | 250W | 9.0m, 29.ft | |
| PG-12000 | 12000 L/Hr | 160W | 4.5m, 14.5ft | |
| PG-15000 | 15000 L/Hr | 200W | 5.0m, 16.4ft | |
| PG-18000 | 18000 L/Hr | 250W | 6.0m, 20.0ft | |
| PG-28000 | 28000 L/Hr | 550W | 7.0m, 23.0ft | |

Magnetic Drive Water

- Innovative structure with aluminum cover ensures liquid passing through without leakage
- Anti-corrosion design used extensively in various industries and applications
- Heavy-duty ceramic axle sleeve for long life durability and reliability
- In-line use only



| MODEL | DESCRIPTION | POWER | Hmax. | RECOMMEND PRICE |
|-------|-------------|-------|--------------|-----------------|
| MD-30 | 3000 L/Hr | 55W | 4.0m, 13.0ft | |
| MD-40 | 3120 L/Hr | 65W | 4.4W, 14.4ft | |
| MD-55 | 4320 L/Hr | 120W | 8.0m, 26.2ft | |
| MD-70 | 4680 L/Hr | 135W | 8.5m, 27.9ft | |

RESUN Low Voltage Pump



King-1LO



King-1ALO



King-2LO / King-2ALO



King-3LO / King-3ALO

- Pump is small but with large flow rate and high total height.
- Ideal for fresh and marine water with the ceramic shaft locator which are durable and not easy to be abraded.

| MODEL | DESCRIPTION | Hmax. | RECOMMEND PRICE |
|-----------|-------------|-------|-----------------|
| King-1LO | 600 L/Hr | 0.9m | |
| King-1ALO | 700 L/Hr | 1.2m | |
| King-2LO | 1000 L/Hr | 1.95m | |
| King-2ALO | 1500 L/Hr | 1.95m | |
| King-3LO | 2400 L/Hr | 2.4m | |
| King-3ALO | 4000 L/Hr | 2.8m | |



RESUN Submersible Spotlight

- Perfectly sealed and waterproof
- Low voltage for safe use, and with safety approved outdoor transformer
- Ideal for fountains, aquariums and ponds
- Compact design with variable installation ways



ALPL35 / ALPL50

- Aluminum enclosure. Lamp is used above or under water
- Square base, stake, three optional aluminum covers and 4 colors of lamp cover included in the unit

• Three front covers optional



SPLI20 / SPLI35

- Lamp is used under water only



MISPLI

- Lamp is used under water only
- With voltage safety approved outdoor plug-in type transformer



SPLI31

- Lamp is used under water only
- Suction cups, square base, and 4 colors of lamp cover included

| MODEL | DESCRIPTION | POWER | RECOMMEND PRICE |
|--------|-----------------------|----------|-----------------|
| MISPLI | Mini Spotlight 12 V | 5W / 10W | |
| SPLI20 | Spotlight, 12 V | 20W | |
| SPLI35 | Spotlight, 12 V | 35W | |
| ALPL35 | Alumin.Pond Lamp, 12V | 35W | |
| ALPL50 | Alumin.Pond Lamp, 12V | 50W | |
| SPLI31 | Spotlight 3 in 1, 12V | 3x20W | |

Magi Jet Internal Filter



- Compact and efficient structure.
- Water flow direction adjustable by the spray bar.
- Oxygen flow achieved with additional kits provided.
- Mechanical and biological filtration realized with easy cleaned and replaceable carbon box and filter sponge, which comes in a handy blister pack.

| MODEL | DESCRIPTION | POWER | RECOMMENDED AQUARIUM SIZE | RECOMMEND PRICE |
|-----------|-----------------|-------|---------------------------|-----------------|
| MAGI-200 | 200L/Hr, 0.5m | 5W | 40L | |
| MAGI-380 | 380L/Hr, 0.9m | 7W | 40-80L | |
| MAGI-700 | 700L/Hr, 1.2m | 10W | 60-150L | |
| MAGI-1000 | 1000L/Hr, 1.95m | 20W | 80-250L | |

NEW

Cruiser Internal Power Filter



- Compact size and easy to install.
- Suitable for both fresh and marine water.
- Complete biological and mechanical filtration system to maintain the water quality.

| MODEL | DESCRIPTION | POWER | Pump Outket Diameter | RECOMMEND PRICE |
|--------|----------------|-------|----------------------|-----------------|
| CS400 | 400L/Hr, 0.7m | 6W | 16mm | |
| CS700 | 700L/Hr, 0.9m | 10W | 16mm | |
| CS1000 | 1000L/Hr, 1.1m | 15W | 16mm | |
| CS1500 | 1500L/Hr, 1.6m | 25W | 16mm | |
| CS2000 | 2000L/Hr, 2.0m | 30W | 16mm | |

RESUN Magi Jet Internal Power Filter



- Compact and efficient structure.
- Water flow direction adjustable by the spray bar.
- Oxygen flow achieved with additional kits provided.
- Mechanical and biological filtration realized with easy cleaned and replaceable carbon box and filter sponge, which comes in a handy blister pack.

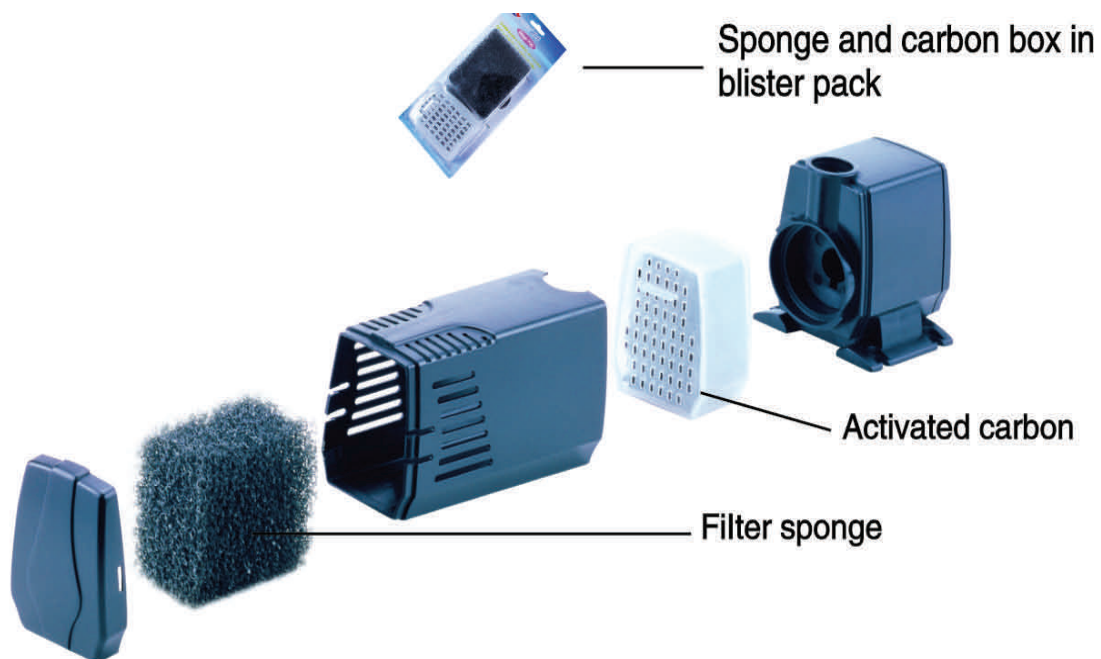

| MODEL | DESCRIPTION | POWER | RECOMMENDED AQUARIUM SIZE | RECOMMEND PRICE |
|-----------|-----------------|-------|---------------------------|-----------------|
| MAGI-200 | 200L/Hr, 0.5m | 5W | 40L | |
| MAGI-380 | 380L/Hr, 0.9m | 7W | 40-80L | |
| MAGI-700 | 700L/Hr, 1.2m | 10W | 60-150L | |
| MAGI-1000 | 1000L/Hr, 1.95m | 20W | 80-250L | |



RESUN

Mini Filter and SP Internal Filter



MINI FILTER

- Easy to operate and noiseless.
- Include filter media (Sponge)

- Economical design. Durable and easy to use
- Use stainless steel shaft and durable magnetic rotor
- Purifies water both mechanically and biologically



SP-2500L / SP-3800L



SP-1100L / SP-1200L



SP-900L / SP-1800L



SP-5200L

- All-in-one filter, easy to operate and maintain
- Purifies water both mechanically and biologically

| MODEL | DESCRIPTION | POWER | RECOMMENDED AQUARIUM SIZE | RECOMMEND PRICE |
|-------------|----------------|-------|---------------------------|-----------------|
| MINI FILTER | 200L/Hr, 0.5m | 5W | Max 60L | |
| SP-1100L | 500L/Hr, 0.7m | 8W | Max 150L | |
| SP-1200L | 700L/Hr, 1.2m | 12W | Max 200L | |
| SP-2500L | 1400L/Hr, 1.5m | 18W | Max 400L | |
| SP-3800L | 2000L/Hr, 1.8m | 25W | Max 500L | |
| SP-900L | 300L/Hr, 0.7m | 5W | | |
| SP-1800L | 1000L/Hr, 1.2m | 18W | | |
| SP-5200L | 2800L/Hr, 3.2m | 60W | | |

INTERNAL FILTERS

RESUN

Nutri Flo Hang On Filter



HF-2001



HF-2002



HF-2003

- Equipped with a complete filter cartridge
- Perfect combination of mechanical and biological filtration
- Adjustable flow rate

| MODEL | DESCRIPTION | POWER | RECOMMENDED AQUARIUM SIZE | RECOMMEND PRICE |
|---------|-------------|-------|---------------------------|-----------------|
| HF-2001 | 340L/Hr | 4.5W | Max 60L | |
| HF-2002 | 570L/Hr | 6W | 40-230L | |
| HF-2003 | 720L/Hr | 7W | 45-300L | |



Biostream External Hang On Filter



- Premium filtration: Provides TRUE 4-stage filtration for these external models
- Earth-friendly design: By replacing the carbon unit far less than the other filters, less waste is sent to landfills
- Low Maintenance cost: Allows the replacement of only the cartridge **GHAT NEEDS TO BE CHANGED**
- Easier tank management: The included zeolite cartridge ensures safer tank startups by deeping Ammonia levels low until a bacteria colony has grown large enough. If a tank needs medicating, the carbon cartridge can be easily removed from the filter pad cartridge, allowing mechanical filtration to continue without interruption

| MODEL | DESCRIPTION | POWER | RECOMMENDED AQUARIUM SIZE | RECOMMEND PRICE |
|--------|-------------|-------|---------------------------|-----------------|
| BS-3i | 100L/Hr | 3W | | |
| BS-15e | 360L/Hr | 5W | Max 60L | |
| BS-40e | 630L/Hr | 6W | Max 150L | |



RESUN

External Canister Filters







EF-600 / EF-800



EF-2800 / EF-2800U



**EF-1200 / EF-1600
EF-1200U / EF-1800U**

-  Powerful and adjustable flow rate
-  Inlet size is much bigger than outlet size for thorough filtration
-  Mechanical, chemical and biological filtration process for maximizing water purification while reproducing beneficial nitrobacteria
-  Innovative structure of UV lamp, optional for extra sterilizing

| MODEL | DESCRIPTION | POWER | Inlet tube Diameter | Outlet tube Diameter | RECOMMEND PRICE |
|----------------------|-------------|-------|---------------------|----------------------|-----------------|
| EF600 | 600L/Hr | 15W | 16mm | 16mm | |
| EF800 | 800L/Hr | 15W | 16mm | 16mm | |
| EF1000 | 1000L/Hr | 19W | 16mm | 16mm | |
| EF1200 | 1200L/Hr | 30W | 19mm | 16mm | |
| EF1200U with UV Lamp | 201200L/Hr | 30W | 19mm | 16mm | |
| EF1600 | 1600L/Hr | 35W | 19mm | 16mm | |
| EF1600U with UV Lamp | 1600L/Hr | 35W | 19mm | 16mm | |
| EF2800 | 2800L/Hr | 60W | 25mm | 19mm | |
| EF2800U with UV Lamp | 2800L/Hr | 60W | 25mm | 19mm | |

INTERNAL FILTERS

RESUN



King Fountain Pump with 10 metre cable



- ▶ More powerful and energy-efficient rare earth rotor
- ▶ Wear-resistant ceramic shaft ensures long life
- ▶ Optional in-line use
- ▶ Encapsulated epoxy resin motor ensures safety, reliability and durability
- ▶ Suitable for both fresh and marine water
- ▶ Choices of fountain jets/kits
- ▶ Suitable for aquarium, water garden fountain and waterfall display

| MODEL | DESCRIPTION | POWER | Pump Outlet Diameter | RECOMMEND PRICE |
|----------|-----------------|-------|----------------------|-----------------|
| King-1F | 380L/Hr, 0.9m | 5W | 13mm | |
| King-1AF | 610L/Hr, 1.2m | 10.5W | 13mm | |
| King-2F | 1100L/Hr, 2m | 17W | 13/19mm | |
| King-2AF | 1500L/Hr, 2m | 20W | 13/19mm | |
| King-3F | 2300L/Hr, 4.5m | 40W | 13/19mm | |
| King-3AF | 4000L/Hr, 2.75m | 70W | 19/25mm | |
| King-4F | 5100L/Hr, 4.5m | 125W | 19/25mm | |
| King-5F | 6200L/Hr, 4.0m | 145W | 19/25mm | |
| King-6F | 8200L/Hr, 5m | 226W | 19/25/32mm | |



RESUN

King Low Voltage Fountain Pump



King-1FLO



King-1AFLO



King-2FLO



King-2AFLO



King-3FLO



King-3AFLO

- Small pump but with large flow rate and high head height.
- Ideal for fresh and marine water with ceramic shaft.
- The motor is sealed with epoxy resin for safety and durability.
- Flow can be adjusted freely.

| MODEL | DESCRIPTION | Pump Outlet Diameter | RECOMMEND PRICE |
|------------|-----------------|----------------------|-----------------|
| King-1FLO | 380L/Hr, 0.9m | 13mm | |
| King-1AFLO | 700L/Hr, 1.2m | 13mm | |
| King-2FLO | 1000L/Hr, 2m | 13/19mm | |
| King-2AFLO | 1500L/Hr, 2m | 13/19mm | |
| King-3FLO | 2400L/Hr, 4.5m | 13/19mm | |
| King-3AFLO | 4000L/Hr, 2.75m | 19/25mm | |

RESUN Sunlike Heaters

- QUARTZ glass tube enriches the superior shatterproof capacity ensuring the heater will not break if outside the water.
- The double layer design ensures complete hermetization.
- Accurate temperature reading.
- Automatically shut-off.
- Completely submersible.



Temperature adjuster

Waterproof cap

Temperature indicator

Shatterproof quartz glass



Recommended Aquarium/Heater

| Aquarium Size (L) | 25 | 50 | 75 | 100 | 150 | 200 | 250 | 300 | |
|------------------------|-----|-----|-----|-----|-----|----------|----------|----------|----------|
| Aquarium Size (Gallon) | 5 | 10 | 15 | 20 | 30 | 45 | 55 | 65 | |
| 5°C 9°F | 25 | 50 | 75 | 100 | 150 | 200 | 250 | 300 | POWER(W) |
| 10°C 18°F | 50 | 75 | 100 | 150 | 200 | 250 | 300 | 2 200 | |
| 20°C 36°F | 100 | 150 | 200 | 250 | 300 | 2 200 | 2 250 | 2 300 | |
| | | | | | | | | | |

| MODEL | DESCRIPTION | POWER | DIMENSION |
|--------|-------------|-------|------------|
| SLK025 | 220-240V | 25W | 27 x 215mm |
| SLK050 | 220-240V | 50W | 27 x 265mm |
| SLK075 | 220-240V | 75W | 27 x 265mm |
| SLK100 | 220-240V | 100W | 27 x 265mm |
| SLK150 | 220-240V | 150W | 27 x 320mm |
| SLK200 | 220-240V | 200W | 27 x 360mm |
| SLK300 | 220-240V | 300W | 27 x 360mm |



RESUN

Macro Chillers

- Intelligent digital control system ensures precise temperature display and easy operation
- ABS plastic shell makes this unit safe and reliable
- Low operating noise
- Unique and innovative design; compact and easy to move
- High quality compressor is durable and energy-efficient
- Corrosion resistant, pure titanium heat exchanger



CL-Series

Electronic Chillers Warmer



CL-85 / CL-150



MINI-20

- Automatic switch for chilling and warming function
- Effective chilling capacity reached by high quality electronic chip
- Low operating noise and energy efficient
- Automatic temperature control system with adjustment by every 1°C
- Ideal for both fresh and marine water

| MODEL | POWER | REFRIGERATING CAPACITY | RECOMMENDED AQUARIUM SIZE | RECOMMEND PRICE |
|---------|---------|------------------------|---------------------------|-----------------|
| CL-85 | 130W | 85W | <60L | |
| CL-150 | 200W | 150W | <120L | |
| MINI-20 | 1/13 HP | 200W | <160L | |
| CL-200 | 1/13 HP | 200W | <160L | |
| CL-280 | 1/10 HP | 280W | <300L | |
| CL-600 | 1/4 HP | 600W | <650L | |
| CL-450 | 1/6 HP | 450W | 450L | |
| CL-650 | 1/4 HP | 650W | 650L | |

RESUN Light Tubes 10,000 Hours



- Wide options of wattage and length. Red, white, and blue lights available
- Long lifetime up to 10,000 hours
- Ideal spectrum for fish and plant growth

| MODEL | DESCRIPTION | POWER | Pump Outlet Diameter |
|--------|----------------|-------|----------------------|
| CS400 | 400L/Hr, 0.7m | 6W | 16mm |
| CS700 | 700L/Hr, 0.9m | 10W | 16mm |
| CS1000 | 1000L/Hr, 1.1m | 15W | 16mm |
| CS1500 | 1500L/Hr, 1.6m | 25W | 16mm |
| CS2000 | 2000L/Hr, 2.0m | 30W | 16mm |

RESUN Filtration Media



Bio Ball

Adopting environmental plastic material with many specifications. All bio balls have wide surfaces for nitrifying bacteria to grow. It can help to establish the most complete and balanced system for biological filtration and can be used in both fresh and marine water tanks.

The wide porous surface provides optimum living condition for large quantities of nitrifying bacteria, thus improving the effect of biological filtration and stabilizing the water quality.



Ceramic Ring



Activated Carbon

Activated carbon is very durable and not easy to break. With perfect absorption capability, it purifies water thoroughly by eliminating the organic compounds, undesirable colours and odours.

| MODEL | DESCRIPTION | WEIGHT | RECOMMEND PRICE |
|-----------|----------------------|--------|-----------------|
| BBAL40 | 40mm Flexible spikes | | |
| BBAL26 | 26mm Flexible spikes | | |
| CARB-150 | Activated carbon | 150g | |
| CARB-300 | Activated carbon | 300g | |
| CARB-500 | Activated carbon | 500g | |
| CARB-1000 | Activated carbon | 1kg | |
| CR-250 | Ceramic ring | 250g | |
| CR-500 | Ceramic ring | 500g | |
| CR-1000 | Ceramic ring | 1kg | |

FILTRATION MEDIA



 Bio purified function

 Both valid in seawater and freshwater



Ammonia absorbing ring



Ammonia absorbing towers



Ammonia absorbing stone



Ceramic towers



Ceramic balls



Ceramic rings

| MODEL | DESCRIPTION | WEIGHT | RECOMMEND PRICE |
|---------|--------------------------|--------|-----------------|
| ATA-265 | Ammonia remover | 500g | |
| HC-1 | Ammonia absorbing rings | 500g | |
| SC-1 | Ammonia absorbing stones | 500g | |
| TC-2 | Ammonia absorbing towers | 500g | |
| HB-2 | Ceramic filtering rings | 500g | |
| QA-3 | Ceramic chemical balls | 500g | |
| QC-2 | Ceramic chemical balls | 500g | |
| TB-3 | Ceramic chemical towers | 500g | |



FILTRATION MEDIA



Glass filtering media

➤ Bio purified function

➤ Both valid in seawater and freshwater

| MODEL | DESCRIPTION | WEIGHT | RECOMMEND PRICE |
|---------|-----------------------|--------|-----------------|
| HB-3 | Glass filtering media | 500g | |
| HB-6 | Glass filtering media | 500g | |
| HC-3 | Glass filtering media | 500g | |
| HB-210 | Glass filtering media | 10kg | |
| HB-610 | Glass filtering media | 10kg | |
| QA-310 | Glass filtering media | 10kg | |
| TB-110 | Glass filtering media | 10kg | |
| TB-310 | Glass filtering media | 10kg | |
| HB-1510 | Glass filtering media | 10kg | |

Cut Your Own Filtering

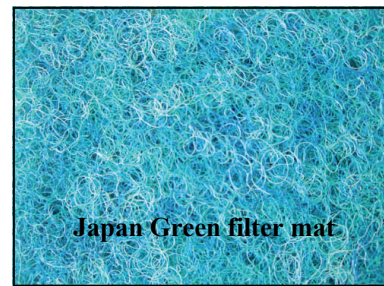
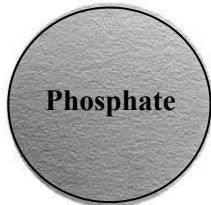

➤ Suitable for all filters that use filter sponge

➤ For freshwater and salt water aquarium

| MODEL | DESCRIPTION | SIZE | RECOMMEND PRICE |
|-----------|---|------------|-----------------|
| FM-4525AR | Filter media ammonia reduction filter mat | 45 x 25 cm | |
| FM-4525PR | Filter media phosphate reduction filter mat | 45 x 25 cm | |
| FM-4525NR | Filter media nitrate reduction filter mat | 45 x 25 cm | |
| FM-4525CA | Filter media carbon filter mat | 45 x 25 cm | |
| FM-4524CO | Filter media cotton filter mat | 45 x 25 cm | |
| FM-2000JA | Filter media Japan green filter mat | 200x100cm | |

SPONGE FILTERS



Super Biochemical sponge filter (Medium) With airlift system, sponge filter features silent operation, and has an excellent filtering effect while oxygenating the water. The specially developed foam materials supports the colonization of bacteria, allowing for mechanical filtration in addition to biological filtration which will break down harmful waste, ammonia and nitrite material, resulting in a cleaner living environment for your fish, particularly they are useful for as breeding filter or as secondary filter.

| MODEL | DESCRIPTION | SIZE |
|--------|---|--------|
| XY-180 | Air operated sponge filters: Cylinder shape | Small |
| XY-280 | Air operated sponge filters: Cylinder shape | Medium |
| XY-380 | Air operated sponge filters: Cylinder shape | Large |

Biological Sponge



SPGE393905

Black sponge 390x390x50



SPGE151550

Black sponge 150x150x500



RSPGE128 Round sponge diameter 128 mm

RSPGE1777 Round sponge diameter 177 mm



RESUN Automatic Fish Feeder

AUTOMATIC FISH FEEDER



AFF-01



AF-2005



AFF-2005D

- Dry, loose flake and pellet food can be used
- Ideal for various sizes of aquariums with options of placing the food feeder on aquarium, free-standing or rim-mounted
- Digital timer for setting up regular feeding programs
- Unique system to prevent food from being moisturized or clogged in dispenser
- Can be operated automatically or manually, making fish-keeping easier

| MODEL | DESCRIPTION |
|-----------|------------------------------------|
| AFF-01 | Battery operated Auto. Fish feeder |
| AFF-2005 | Battery operated Auto. Fish feeder |
| AFF-2005D | Battery operated Auto. Fish feeder |

RESUN AQUARIUM ACCESSORIES



Resun offers a complete range of air pump accessories, such as air filters, air flow control valves, check valves, air tube connectors, plastic tubing, air stones and flexible air curtains in fine packaging for great service, convenience and tailored customer applications



| MODEL | DESCRIPTION |
|--------|--------------------|
| AC-30 | Air curtain 30 cm |
| AC-45 | Air curtain 45 cm |
| AC-60 | Air curtain 60 cm |
| AC-75 | Air curtain 75 cm |
| AC-90 | Air curtain 90 cm |
| AC-120 | Air curtain 120 cm |



Cross control valve

ACV-01



Tee control valve

ACV-02



ACV-03

Resun offers a complete range of air pump accessories, such as air filters, air flow control valves, check valves, air tube connectors, plastic tubing, air stones and flexible air curtains in fine packaging for great service, convenience and tailored customer applications



'Y' shape with three ways

ATC-01



Straight shape with two ways

ATC-02

➤ Resun offers a complete range of air pump accessories, such as air filters, air flow control valves, check valves, air tube connectors, plastic tubing, air stones and flexible air curtains in fine pack-



CV-D



CV-C

➤ Resun offers a complete range of air pump accessories, such as air filters, air flow control valves, check valves, air tube connectors, plastic tubing, air stones and flexible air curtains in fine packaging for great service, convenience and tailored customer applications



ALT-200 / ALT-100

Air line tubing

| MODEL | DESCRIPTION |
|---------|----------------------|
| ALT-200 | Airline tubing 200 m |
| ALT-100 | Airline tubing 100 m |

RESUN AQUARIUM ACCESSORIES



| MODEL | DESCRIPTION |
|---------|-----------------------------------|
| PVC812 | 8/12mm PVC tubing / 5mm per roll |
| PVC1216 | 12/16mm PVC tubing / 5mm per roll |
| PVC1622 | 16/22mm PVC tubing / 5mm per roll |
| PVC2026 | 20/26mm PVC tubing / 5mm per roll |
| PVC2430 | 24/30mm PVC tubing / 5mm per roll |
| PVC3036 | 30/36mm PVC tubing / 5mm per roll |

Resun offers a complete range of air pump accessories, such as air filters, air flow control valves, check valves, air tube connectors, plastic tubing, air stones and flexible air curtains in fine packaging for great service, convenience and tailored customer applications



RST-01



RST-02



RST-03



RST-04

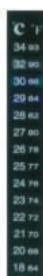

RST-06

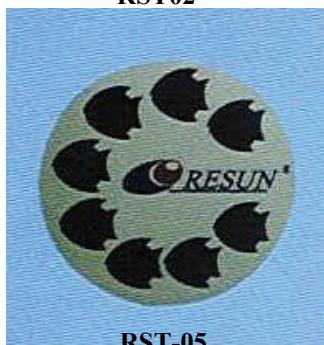

RST-05



RST-01P

Resun offers a wide range of aquarium accessories in fine packaging for great service convenience and tailored customer applications

| MODEL | DESCRIPTION |
|---------|-----------------------------|
| RST-01 | Sector thermometer |
| RST-02 | Ellipse thermometer |
| RST-03 | Glass thermometer |
| RST-04 | Glass thermometer |
| RST-05 | Stick on thermometer: Round |
| RST-06 | Stick on thermometer: Long |
| RST-01P | Ornamental thermometer |



RESUN AQUARIUM ACCESSORIES

ACCESSORIES

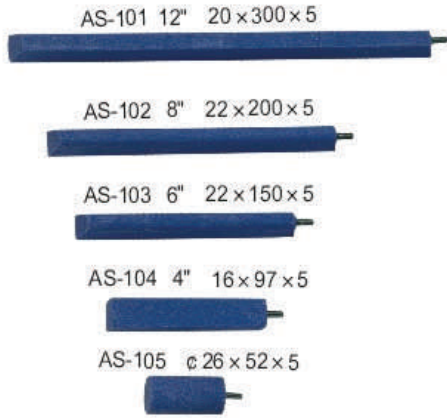

| MODEL | DESCRIPTION |
|--------|-------------------------------------|
| AB-044 | PVC encased air bar: 4' tank , 44" |
| AB-040 | PVC encased air bar: 4' tank , 40" |
| AB-034 | PVC encased air bar: 3' tank , 34" |
| AB-022 | PVC encased air bar: 2' tank , 22" |
| AB-018 | PVC encased air bar: 20" tank , 18" |
| AB-016 | PVC encased air bar: 18" tank , 16" |
| AB-014 | PVC encased air bar: 16" tank , 14" |
| AB-012 | PVC encased air bar: 14" tank , 12" |
| AB-010 | PVC encased air bar: 12" tank , 10" |
| AB-08 | PVC encased air bar: 10" tank , 8" |



AS-106



AS-107



AS-108



AS-109



Elbow joint

Curve hose connector for hose of 8mm,12mm,16mm inner diameter

| MODEL | DESCRIPTION |
|-------|---------------------|
| EJT08 | Elbow joint size 08 |
| EJT12 | Elbow joint size 12 |
| EJT16 | Elbow joint size 16 |



T joint

| MODEL | DESCRIPTION |
|-------|-----------------|
| TJT08 | T joint size 08 |
| TJT12 | T joint size 12 |
| TJT16 | T joint size 16 |



U joint

| MODEL | DESCRIPTION |
|-------|-----------------|
| UJT08 | U joint size 08 |
| UJT12 | U joint size 12 |
| UJT16 | U joint size 16 |

RESUN AQUARIUM ACCESSORIES



ANGLE-001

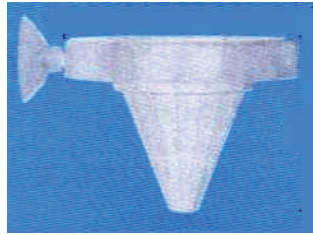

WB-01/ Feeder cone

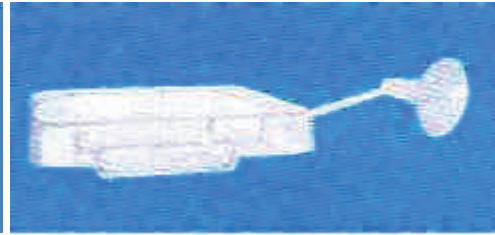

FR-01/ Floating feeding



FH-03 / Fish net breeder



HATCH-01
GUPPY TRAP



FH-02 / Closed style guppy



SC-200



SC-210



AS-049



FTDC-001 Fish tank divider cup



AHSC-001 Air hose suction cup



Suction cup

| MODEL | DESCRIPTION |
|----------|--------------------|
| SC-0001S | Suction cup small |
| SC-0001M | Suction cup medium |
| SC-0001L | Suction cup large |



Magnetic Cleaner

| MODEL | DESCRIPTION |
|--------|------------------------------------|
| NF07-S | Never fail magnetic cleaner small |
| NF07-M | Never fail magnetic cleaner medium |
| NF07-L | Never fail magnetic cleaner large |



Fish Nets

| MODEL | DESCRIPTION |
|--------|--------------|
| FN-030 | Fish net 3" |
| FN-040 | Fish net 4" |
| FN-050 | Fish net 5" |
| FN-060 | Fish net 6" |
| FN-080 | Fish net 8" |
| FN-100 | Fish net 10" |
| FN-120 | Fish net 12" |



Metal Handle Fish Nets

| MODEL | DESCRIPTION |
|---------|---------------------------|
| FNC-090 | Noncorrosion fish net 9" |
| FNC-100 | Noncorrosion fish net 10" |
| FNC-110 | Noncorrosion fish net 11" |
| FNC-120 | Noncorrosion fish net 12" |

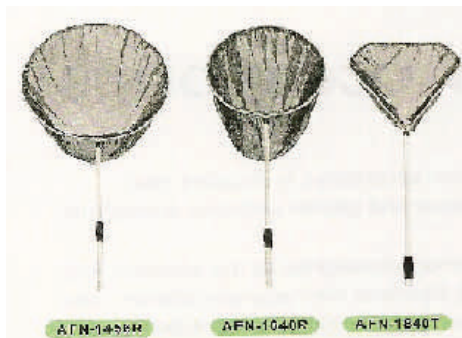

| MODEL | DESCRIPTION |
|-----------|--------------------------------------|
| AFN-1640R | Pond fish net with extendable handle |
| AFN-1456R | Pond fish net with extendable handle |
| AFN-1840T | Pond fish net with extendable handle |
| AFN-1638S | Pond fish net with extendable handle |

RESUN AQUARIUM ACCESSORIES



| MODEL | DESCRIPTION |
|---------|---------------------|
| NB-1206 | Netting bag 12"x6" |
| NB-1606 | Netting bag 16"x6" |
| NB-1812 | Netting bag 18"x12" |
| NB-2216 | Netting bag 22"x16" |
| NB-2415 | Netting bag 25x15cm |
| NB-4020 | Netting bag 40x20cm |

Netting Bags for carbon,ceramic and substrate



Pond thermometer

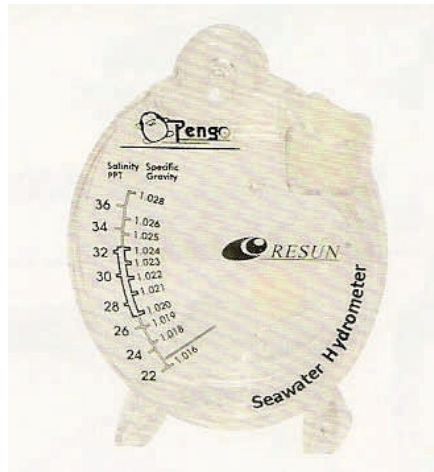

SWH-04

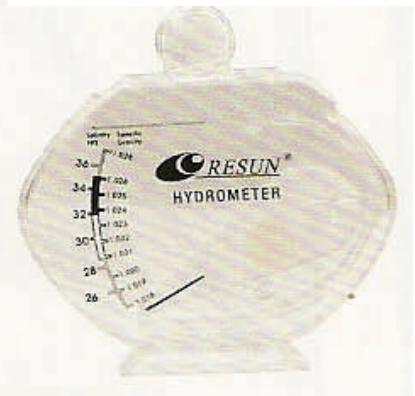

SWH-05

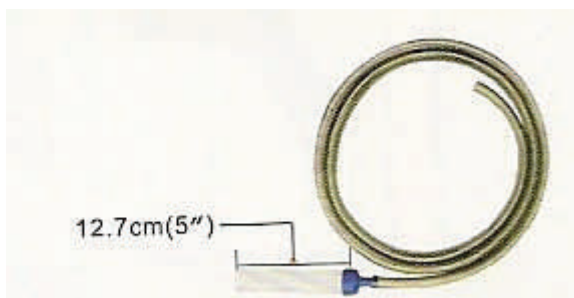

VC-01

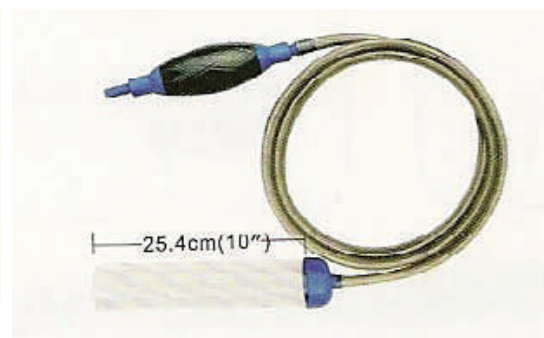

VC-03B



RESUN DM Series Tanks

Modern design with high quality bent glass.
 Independent top filter and unique oxygenation mechanism (no need for additional air pump, with complete filter media included for mechanical and biological filtration.
 Safety approved submersible pump provides quiet, reliable and powerful filtration capability.
 Under gravel filter system cultivates beneficial nitrobacteria and dissolves harmful organisms.
 Equipped with energy-efficient lamps, good heat dispersing capacity.
 Spaces designed for heater and auto-feeder.
 Available in Black and Gray. Cabinets also available.



| MODEL | INCLUDES | AQUARIUM SIZE | DIMENSION |
|-------|--------------------------------|---------------|-------------------|
| DM320 | 18W White Globe and SP500 | 22L | 320 x 250 x 395mm |
| DM400 | 25W White Globe and SP800 | 40L | 407 x 302 x 470mm |
| DM600 | 2 x 18W White Globes and SP800 | 65L | 607 x 320 x 475mm |
| DM800 | 2 x 25W White Globes and SP980 | 120L | 800 x 400 x 545mm |

DM SERIES TANKS

RESUN BALL TANKS



NEW



- Safety with low voltage
- Use either battery or USB as power supply
- Great for desktop
- Recommended to keep betta



RESUN HEXAGON TANK

- Safety with low voltage
- Energy saving with LED lighting
- Provide modes of daylight and moonlight
- Made of high-clarity plastic
- Panoramic view of the aquatic life in the tank



Enjoy the innovation of LED!



HEX-08



LED Lighting



Feeding Door



Filter Cartridge



Filter (CX-200)

| MODEL | VOLT.FREQ | | FILTER | AQUARIUM | DIMENSION |
|--------|--------------------------------------|---------------------|--------|----------|---------------|
| | Transformer | Filter & LED | | | |
| HEX-08 | AC 110-120V 220-240V 50Hz-60Hz | AC 12V 50Hz-60Hz | CX-200 | 8L/2Gal | 242x210x310mm |

AQUARIUM TANKS

CLEAR CUBE PREMIUM AQUARIUM



30 pcs LED



ClearMax Filter



- Safety with low voltage
- Energy saving with LED lighting
- Innovative patent pending filter
- Ultra clear glass cube
- Glass cover to prevent fish from jumping out

| MODEL | FILTER | LAMP | AQUARIUM | DIMENSION |
|-------|--------|-------|------------|---------------|
| CC-30 | CX-200 | 8S-30 | 32L17.9Gal | 350x320x31Smm |

RESUN ICUBE TANKS



PATENTED
Color Enhancement
Technology

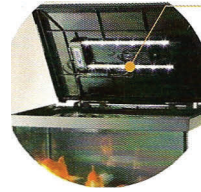

Color enhancement LED

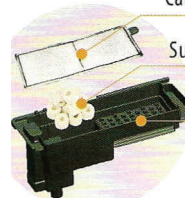

Cartridge Filter

Super Ceramic Rings

Top Filter

Black

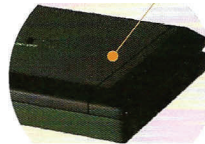

Grey

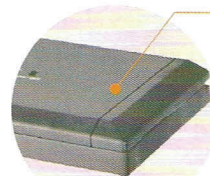

- ▶ Patented color enhancement LED to bring dreamlike color to the aquatic life in the tank.
- ▶ Fully waterproof LED stripe with long life of 30,000 hours .
- ▶ Powerful internal bio-filter.

Dimension:
415x284x356mm
Capacity: 30L(8Gal)



RESUN FISHHOME AQUARIUM

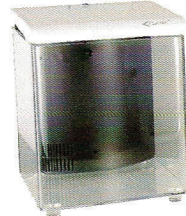

White

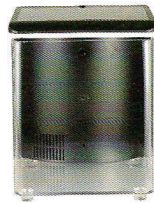

Black

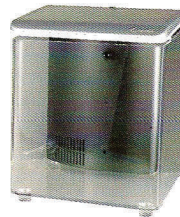

Silver







Enlarge the space at the sides



Patented color enhancement LED



Patented arc shape back filtration system

-  Patented color enhancement LED to bring dreamlike color to the aquatic life in the tank.
-  Fully waterproof LED stripe with long life of 30,000 hours.
-  Patented design of arc shape back filtration system to enlarge the side view space.
-  Made of high clarity acrylic, safe and shatterproof

INTERNAL FILTERS

RESUN CLARITY AQUARIUM KIT

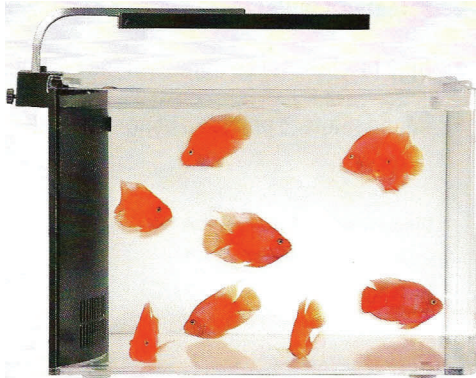

CT19

CT19

Dimension: 360x242x252mm

Capacity: 19L(5Gal)

LED Light: LM18

Power: 7.SW



CT12

CT12

Dimension: 240x240x252mm

Capacity: 12L(3Gal)

LED Light: LM12A

Power: 6.SW



CT08





CT08

Dimension: 200x200x232mm

Capacity: 8L(2Gal)

LED Light: LM12

Power: 6.SW

-  Made of high clarity acrylic, safe and shatterproof.
-  Patented design of arc shape back filtration system to enlarge the side view space.
-  Easy-to-replace filter cartridge.
-  Patented color enhancement LED.
-  All in one, easy to start.



Only CT19

Bio Media cartridge

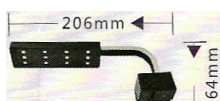

LM12

Patented color enhancement LED

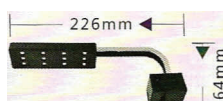

LM12A

Patented color enhancement LED

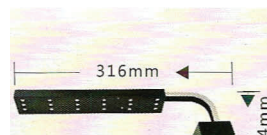

LM18

Patented color enhancement LED

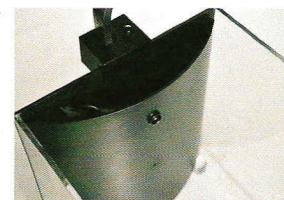

Patented arc shape back filtration system



RESUN CRYSTAL PLACE



CP-18

- Patented double layer aquarium body.
- High brightness LED light from the
- Round shape to provide a panoramic underwater

Dimension: 0156xH230mm

Capacity: 1.8L(0.45Gal)

Including: plant IPC

Color gravel 50pcs

LED light



AP-0128

MB soy



LED Light



AP-

- Patented design with apple shape windows at 4 sides.
- High brightness LED lighting from the bottom.
- Colorful vision.

Dimension: 150x150x182mm

Capacity: 3.0L(0.75Gal)

Including: plant IPC

Color gravel 50pcs

LED light



AW30

RESUN BETTA TOWER



BT20

- Patented tower shape design
- 3x AAA battery operated LED light, easy to move
- Apple and frame shape window at different sides for

Dimension: 146x97x210mm

Capacity: 2L(0.5Gal)

Including: plant IPC

Color gravel 50pcs

LED light

FANCY APPLE



- Patented apple shape design, great for both desktop and wall mounting.
- Made of high-clarity acrylic.
- Can be used to keep fish or grow plants

Dimension: 216x110x220mm

Capacity: 1.8L(0.45Gal)

Including: plant IPC

Color gravel 50pcs





COLOR ENHANCING LED LIGHT

LIGHT

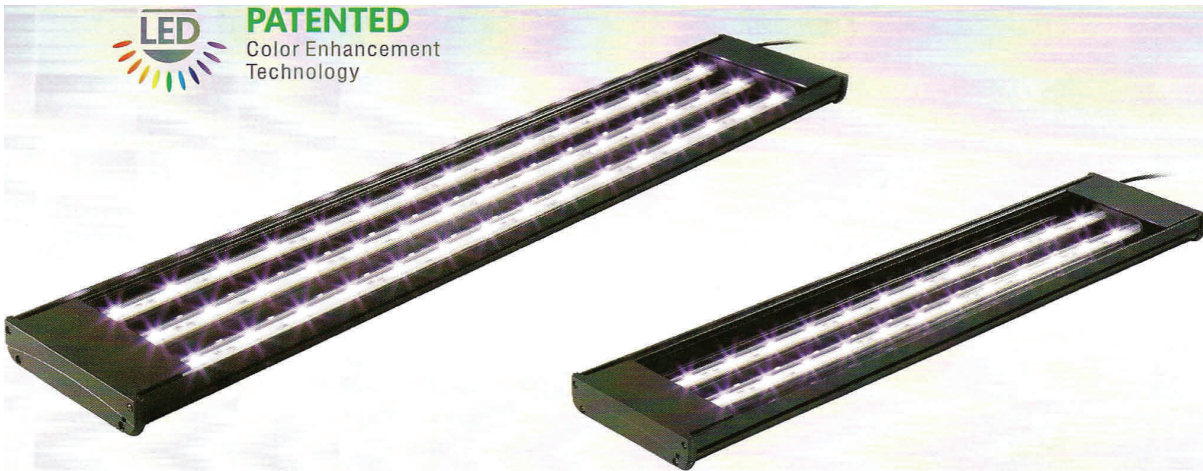

- LED with patented color enhancement technology to significantly enhance the color of the aquatic life in the aquarium.
- Safe with patented waterproof light stripe.
- Low heat from the light, no impact on the water temperature.
- Long life of *over* 30,000 hours.
- Anodized aluminum cover.

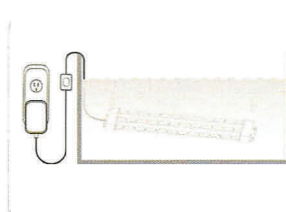

| MODEL | FREQ | POWER | LED | LENGTH |
|---------|---------|-------|-----------------|-------------|
| LED 20B | 50/60Hz | 9W | 3tubes x 9pes | 50CM (20") |
| LED 24B | 50/60Hz | 12W | 3tubes X 12pes | 60CM (24") |
| LED 30B | 50/60Hz | 14W | 3tubes x 15pes | 75CM (30") |
| LED 36B | 50/60Hz | 19W | 3tubes x 21 pes | 90CM (36") |
| LED 48B | 50/60Hz | 22W | 3tubes X 30pes | 120CM (48") |

MAGIC LED LIGHT STRIP

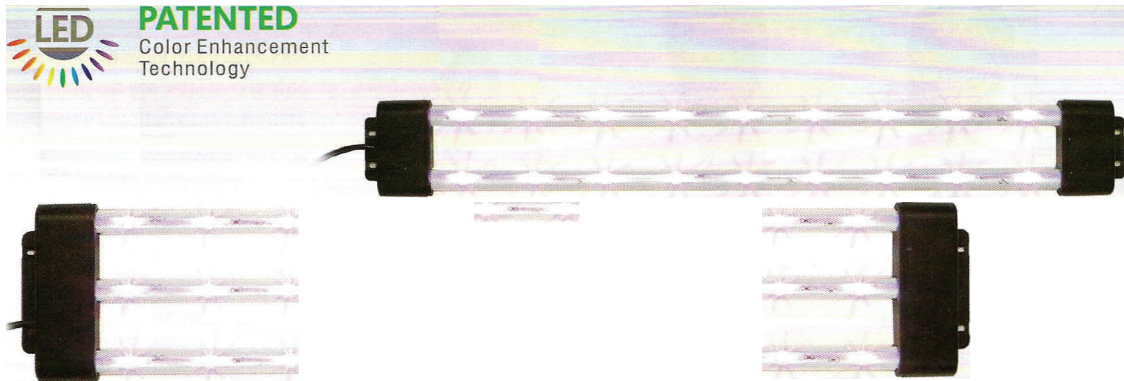

- LED with patented color enhancement technology to significantly enhance the color of the aquatic life in the aquarium.
- Safe with patented waterproof light stripe.
- Low heat from the light, no impact on the water temperature.
- Long life of over 30,000 hours.
- Anodized aluminium

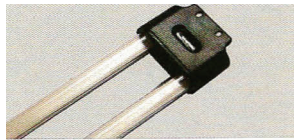

Patented waterproof light stripe



Submersible light stripe



| MODEL | POWER | LED | LENGTH |
|-------|-------|-----------------|------------|
| LS20B | 9W | 3tubes x 9pcs | 50CM (20") |
| LS24B | 12W | 3tubes x 12pes | 60CM (24") |
| LS30B | 14W | 3tubes x 15pes | 75CM (30") |
| LS36B | 19W | 3tubes x 21 pes | 90CM (36") |
| LS48B | 22W | 3tubes x 30pcs | 115CM(48") |

NEW

KING KONG HEATER

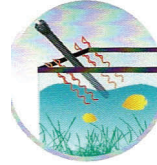

DRY RUN PROTECTION

Safe and reliable dry run protection to cut off power automatically when heater is out of water.



RIGID

Cover made of engineering level plastic, highly rigid and reliable.

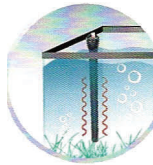

SHATTERPROOF

Double layer protection in structure to resist shattering.



FREE POSITIONING

Unique waterproof design; can be positioned at any place in the tank



SMARTTEMPERATURE (ONTRAL)

Smart temperature control to ensure the accuracy

| MODEL | FREQ | POWER | TANK SIZE |
|-------|----------|-------|-----------|
| HT50 | 50/60Hz | 50W | 20-50l |
| HT100 | 50/60 Hz | 100W | 50-100L |
| HT150 | 50/60Hz | 150W | 100-150l |
| HT200 | 50/60Hz | 200W | 100-200l |
| HT250 | 50/60Hz | 250W | 200-300l |
| HT300 | 50Hz | 300W | 200-300L/ |

HEATER



MH75



MH150

- Good for both fresh and marine water.
- Fully sealed, can be used submersible.
- Compact in size, easy to put into any place in the tank.
- Great for nano tanks such as betta tank

| MODEL | FREQ | POWER |
|-------|----------|-------|
| MH75 | 50/60 Hz | 7.5W |
| MH150 | 50/60 Hz | 15W |



ABSOLUTE

CROC WATER PUMP



Energy saving



- Automatic frequency convertible motor with extremely high power efficiency, save 50% energy comparing with traditional pumps.
- Quiet, compact, light in weight, can be used both indoor and outdoor.
- Patented design of the front housing for water inlet to efficiently avoid the inlet from being blocked by sundries

| Model | Freq | Power | H Max | Q Max | Outlet Size |
|--------|-----------|-------|-------|----------|-------------|
| C3000 | 50Hz/60Hz | 29W | 3.2m | 3000L/H | 01" |
| C4000 | 50Hz/60Hz | 32W | 3.2m | 4000L/H | 01" |
| C5000 | 50Hz/60Hz | 40W | 3.4m | 5000L/H | 01" |
| C6000 | 50Hz/60Hz | 45W | 3.5m | 6000L/H | 01" |
| C8000 | 50Hz/60Hz | 70W | 3.8m | 8000L/H | 01 1/2" |
| C10000 | 50Hz/60Hz | 88W | 4.2m | 10000L/H | 01 3/4" |
| C12000 | 50Hz/60Hz | 106W | 5.0m | 12000L/H | 01 1/2" |

CROC WATER PUMP